



Skyworks Solutions, Inc.

AS169-73LF

Part Number:	AS169-73LF
Manufacturer/Brand:	Skyworks Solutions, Inc.
Product description:	IC SW SPDT 300K-2.5GHZ SOT-6
Datasheets:	AS169-73LF.pdf
RoHS Status:	 Lead free / RoHS Compliant
Stock Condition:	68201 pcs stock
Ship From:	Hong Kong
Shipment Way:	DHL/Fedex/TNT/UPS/EMS

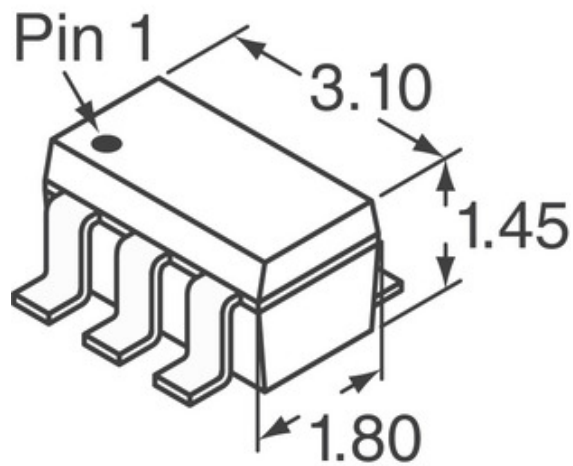

Image may be representation. See specifications for product details.

[REQUEST FOR QUOTATION](#)











Specifications of AS169-73LF

PART NUMBER	AS169-73LF
MANUFACTURER	Skyworks Solutions, Inc.
DESCRIPTION	IC SW SPDT 300K-2.5GHZ SOT-6
LEAD FREE STATUS / ROHS STATUS	Lead free / RoHS Compliant
QUANTITY AVAILABLE	68201 pcs
DATA SHEET	AS169-73LF.pdf
VOLTAGE - SUPPLY	3V
TOPOLOGY	Reflective
TEST FREQUENCY	2.5GHz
SUPPLIER DEVICE PACKAGE	SOT-6
SERIES	-
RF TYPE	802.11b/g Bluetooth
PACKAGING	Cut Tape (CT)
PACKAGE / CASE	SOT-6
P1DB	34dBm
OTHER NAMES	863-1002-1
OPERATING TEMPERATURE	-40°C ~ 85°C
MOISTURE SENSITIVITY LEVEL (MSL)	1 (Unlimited)
LEAD FREE STATUS / ROHS STATUS	Lead free / RoHS Compliant
ISOLATION	24dB
INSERTION LOSS	0.4dB
IMPEDANCE	50 Ohm
IIP3	50dBm
FREQUENCY RANGE	300KHz ~ 2.5GHz
FEATURES	-
DETAILED DESCRIPTION	RF Switch IC 802.11b/g Bluetooth SPDT 2.5GHz 50 Ohm SOT-6
CIRCUIT	SPDT

Related Tags

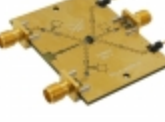
Skyworks Solutions, Inc. AS169-73LF	AS169-73LF Distributor	AS169-73LF Supplier
AS169-73LF Price	AS169-73LF Pictures	AS169-73LF Image
AS169-73LF PDF Datasheet	AS169-73LF Download Datasheet	AS169-73LF Datasheet
AS169-73LF Stock	Buy AS169-73LF	Buy Skyworks Solutions, Inc. AS169-73LF
Skyworks Solutions, Inc. AS169-73LF	Skyworks Solutions, Inc. Supplier	Skyworks Solutions, Inc. Distributor
Skyworks Solutions, Inc. AS169-73LF	Skyworks Solutions Inc. AS169-73LF	

Related Products

 <p>AS1601-7R Manufacturers: Bel Description: DC/DC CONVERTER 24V 100W In stock: 6084 pcs</p> <p>RFQ</p>	 <p>AS1702-T Manufacturers: ams Description: IC AMP AUD 1.8W ADJ GAIN 10-MSOP In stock: 134749 pcs</p> <p>RFQ</p>
 <p>AS168X-CB1H150N-A5 Manufacturers: Schurter Description: CIR BRKR THRM MAG 15A 277V 65V In stock: 1333 pcs</p> <p>RFQ</p>	 <p>AS1701 DB Manufacturers: ams Description: BOARD DEMO AS1701 In stock: 1324 pcs</p> <p>RFQ</p>
 <p>AS1545 Manufacturers: ams Description: IC ADC 12BIT 12CH 1M 32-TQFN In stock: 4358 pcs</p> <p>RFQ</p>	 <p>AS1701-T Manufacturers: ams Description: IC AMP AUDIO POWER 1.6W 8-MSOP In stock: 6852 pcs</p> <p>RFQ</p>
 <p>AS16000001 Manufacturers: TXC Corporation Description: CRYSTAL 16MHZ 12PF THROUGH HOLE In stock: 326761 pcs</p> <p>RFQ</p>	 <p>AS169-73LF-EVB Manufacturers: Skyworks Solutions, Inc. Description: BOARD EVAL SPDT SWITCH AS169-73 In stock: 887 pcs</p> <p>RFQ</p>
 <p>AS168X-CB3H300-A3 Manufacturers: Schurter Description: CIR BRKR THRM MAG 30A 480V 65V In stock: 753 pcs</p> <p>RFQ</p>	 <p>AS1701 Manufacturers: ams Description: IC AMP AUDIO POWER 1.6W 8-MSOP In stock: 5692 pcs</p> <p>RFQ</p>
 <p>AS1601-9R Manufacturers: Bel Description: DC/DC CONVERTER 24V 101W In stock: 134 pcs</p> <p>RFQ</p>	 <p>AS1702 Manufacturers: ams Description: IC AMP AUDIO MONO 1.8W 10-MSOP In stock: 4850 pcs</p> <p>RFQ</p>