

Honeywell

Honeywell Sensing and Productivity Solutions

MLH250PSB06B

| | |
|----------------------|--|
| Part Number: | MLH250PSB06B |
| Manufacturer/Brand: | Honeywell Sensing and Productivity Solutions |
| Product description: | SENSOR SEALED GAUGE 0-250 PSI |
| Datasheets: | 1.MLH250PSB06B.pdf 2.MLH250PSB06B.pdf |
| RoHS Status: |  Lead free / RoHS Compliant |
| Stock Condition: | 6704 pcs stock |
| Ship From: | Hong Kong |
| Shipment Way: | DHL/Fedex/TNT/UPS/EMS |

[REQUEST FOR QUOTATION](#)

Productivity Solutions

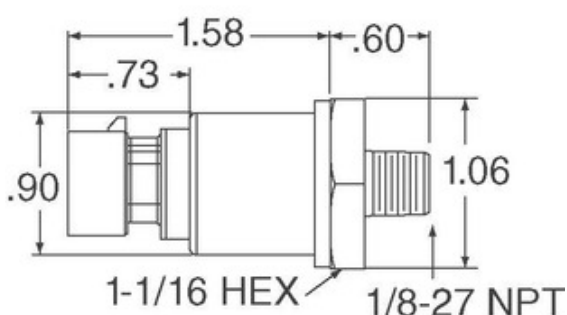

Image may be representation. See specifications for product details.









Specifications of MLH250PSB06B

| | |
|----------------------------------|--|
| PART NUMBER | MLH250PSB06B |
| MANUFACTURER | Honeywell Sensing and Productivity Solutions |
| DESCRIPTION | SENSOR SEALED GAUGE 0-250 PSI |
| LEAD FREE STATUS / ROHS STATUS | Lead free / RoHS Compliant |
| QUANTITY AVAILABLE | 6704 pcs |
| DATA SHEET | 1.MLH250PSB06B.pdf 2.MLH250PSB06B.pdf |
| VOLTAGE - SUPPLY | 9.5 V ~ 30 V |
| TERMINATION STYLE | Packard Metripak 150 |
| SUPPLIER DEVICE PACKAGE | - |
| SERIES | MLH |
| PRESSURE TYPE | Sealed Gauge |
| PORT STYLE | Threaded |
| PORT SIZE | Male - 1/8" (3.18mm) NPT |
| PACKAGE / CASE | Cylinder, Metal |
| OUTPUT TYPE | Analog Current |
| OUTPUT | 4 mA ~ 20 mA |
| OPERATING TEMPERATURE | -40°C ~ 125°C |
| OPERATING PRESSURE | 250 PSI (1723.69 kPa) |
| MOISTURE SENSITIVITY LEVEL (MSL) | 1 (Unlimited) |
| MAXIMUM PRESSURE | 750 PSI (5171.07 kPa) |
| LEAD FREE STATUS / ROHS STATUS | Lead free / RoHS Compliant |
| FEATURES | Amplified Output, Temperature Compensated |
| DETAILED DESCRIPTION | Pressure Sensor 250 PSI (1723.69 kPa) Sealed Gauge Male - 1/8" (3.18mm) NPT 4 mA ~ 20 mA Cylinder, Metal |
| ACCURACY | ±0.25% |

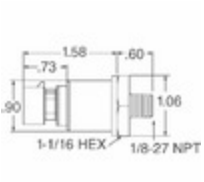
Related Tags

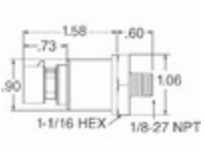
| | | |
|---|---|---|
| Honeywell Sensing and Productivity Solutions MLH250PSB06B | MLH250PSB06B Distributor | MLH250PSB06B Supplier |
| MLH250PSB06B Price | MLH250PSB06B Pictures | MLH250PSB06B Image |
| MLH250PSB06B PDF Datasheet | MLH250PSB06B Download Datasheet | MLH250PSB06B Datasheet |
| MLH250PSB06B Stock | Buy MLH250PSB06B | Buy Honeywell Sensing and Productivity Solutions MLH250PSB06B |
| Honeywell Sensing and Productivity Solutions MLH250PSB06B | Honeywell Sensing and Productivity Solutions Supplier | Honeywell Sensing and Productivity Solutions Distributor |
| Honeywell Sensing and Productivity Solutions MLH250PSB06B | HONEYWELL MLH250PSB06B | Honeywell Sensing and Control EMEA MLH250PSB06B |
| Honeywell Sensing and Productivity Solutions T&M MLH250PSB06B | | |

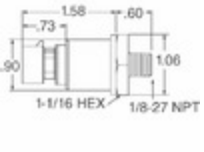
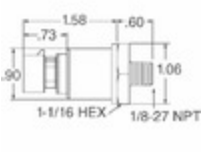
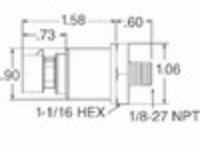
Related Products

| | |
|---|---|
|  <p>MLH250PGL06G Manufacturers: Honeywell Sensing and Productivity Solutions Description: MLH ALL METAL PRESS SENSE -ATF In stock: 6559 pcs</p> <p>RFQ</p> |  <p>MLH250PSB01B Manufacturers: Honeywell Sensing and Productivity Solutions Description: SENSOR AMP 250PSI 4-20MA OUT In stock: 786 pcs</p> <p>RFQ</p> |
|  <p>MLH250PSB01D Manufacturers: Honeywell Sensing and Productivity Solutions Description: SENSOR SEALED GAUGE 0-250 PSI In stock: 895 pcs</p> <p>RFQ</p> |  <p>MLH250PSL09A Manufacturers: Honeywell Sensing and Productivity Solutions Description: SENSOR AMP 250PSI .5-4.5VDC OUT In stock: 4858 pcs</p> <p>RFQ</p> |
|  <p>MLH250PSB06A Manufacturers: Honeywell Sensing and Productivity Solutions Description: SENSOR SEALED GAUGE 0-250 PSI In stock: 1058 pcs</p> <p>RFQ</p> |  <p>MLH250PSB09A Manufacturers: Honeywell Sensing and Productivity Solutions Description: SENSOR AMP 250PSI .5-4.5VDC OUT In stock: 989 pcs</p> <p>RFQ</p> |
|  <p>MLH250PSL14A Manufacturers: Honeywell Sensing and Productivity Solutions Description: SENSOR SEALED GAUGE 0-250 PSI In stock: 1036 pcs</p> <p>RFQ</p> |  <p>MLH250PSM01B Manufacturers: Honeywell Sensing and Productivity Solutions Description: MLH ALL METAL PRESS SENSE -ATF In stock: 6164 pcs</p> <p>RFQ</p> |
|  <p>MLH250PSM06G Manufacturers: Honeywell Sensing and Productivity Solutions Description: SENSOR SEALED GAUGE 0-250 PSI In stock: 690 pcs</p> <p>RFQ</p> |  <p>MLH250PSM01G Manufacturers: Honeywell Sensing and Productivity Solutions Description: SENSOR SEALED GAUGE 0-250 PSI In stock: 6891 pcs</p> <p>RFQ</p> |
|  <p>MLH250PGP06C Manufacturers: Honeywell Sensing and Productivity Solutions Description: SENSOR AMP 250PSI 1-6VDC OUT In stock: 5085 pcs</p> <p>RFQ</p> |  <p>MLH250PSB01A Manufacturers: Honeywell Sensing and Productivity Solutions Description: SENSOR AMP 250PSI .5-4.5VDC OUT In stock: 934 pcs</p> <p>RFQ</p> |