

Honeywell

Honeywell Sensing and Productivity Solutions

MLH250BSG14D

Part Number:	MLH250BSG14D
Manufacturer/Brand:	Honeywell Sensing and Productivity Solutions
Product description:	SENSOR SEALED GAUGE 0-250 BAR
Datasheets:	1.MLH250BSG14D.pdf 2.MLH250BSG14D.pdf
RoHs Status:	 Lead free / RoHS Compliant
Stock Condition:	5355 pcs stock
Ship From:	Hong Kong
Shipment Way:	DHL/Fedex/TNT/UPS/EMS

[REQUEST FOR QUOTATION](#)

Productivity Solutions

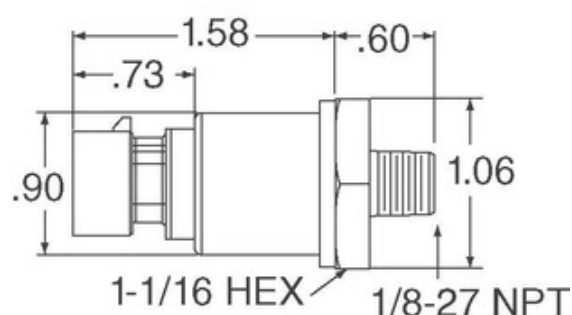

Image may be representation. See specifications for product details.





Specifications of MLH250BSG14D

PART NUMBER	MLH250BSG14D
MANUFACTURER	Honeywell Sensing and Productivity Solutions
DESCRIPTION	SENSOR SEALED GAUGE 0-250 BAR
LEAD FREE STATUS / ROHS STATUS	Lead free / RoHS Compliant
QUANTITY AVAILABLE	5355 pcs
DATA SHEET	1.MLH250BSG14D.pdf 2.MLH250BSG14D.pdf
VOLTAGE - SUPPLY	14 V ~ 30 V
TERMINATION STYLE	DIN
SUPPLIER DEVICE PACKAGE	-
SERIES	MLH
PRESSURE TYPE	Sealed Gauge
PORT STYLE	Threaded
PORT SIZE	Male - 1/4" (6.35mm) BSP
PACKAGE / CASE	Cylinder, Metal
OUTPUT TYPE	Analog Voltage
OUTPUT	0.25 V ~ 10.25 V
OPERATING TEMPERATURE	-40°C ~ 125°C
OPERATING PRESSURE	3625.94 PSI (25000 kPa)
MOISTURE SENSITIVITY LEVEL (MSL)	1 (Unlimited)
MAXIMUM PRESSURE	7251.89 PSI (50000 kPa)
LEAD FREE STATUS / ROHS STATUS	Lead free / RoHS Compliant
FEATURES	Amplified Output, Temperature Compensated
DETAILED DESCRIPTION	Pressure Sensor 3625.94 PSI (25000 kPa) Sealed Gauge Male - 1/4" (6.35mm) BSP 0.25 V ~ 10.25 V Cylinder, Metal
ACCURACY	±0.25%

Related Tags

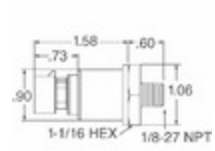
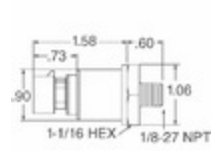
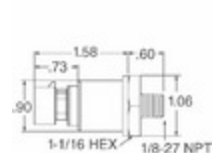
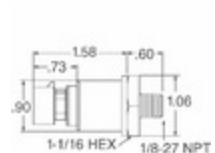
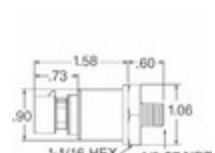
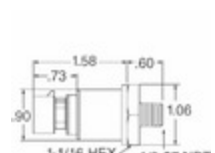
Honeywell Sensing and Productivity Solutions MLH250BSG14D	MLH250BSG14D Distributor	MLH250BSG14D Supplier
MLH250BSG14D Price	MLH250BSG14D Pictures	MLH250BSG14D Image
MLH250BSG14D PDF Datasheet	MLH250BSG14D Download Datasheet	MLH250BSG14D Datasheet
MLH250BSG14D Stock	Buy MLH250BSG14D	Buy Honeywell Sensing and Productivity Solutions MLH250BSG14D
Honeywell Sensing and Productivity Solutions MLH250BSG14D	Honeywell Sensing and Productivity Solutions Supplier	Honeywell Sensing and Productivity Solutions Distributor
Honeywell Sensing and Productivity Solutions MLH250BSG14D	HONEYWELL MLH250BSG14D	Honeywell Sensing and Control EMEA MLH250BSG14D
Honeywell Sensing and Productivity Solutions T&M MLH250BSG14D		

Related Products

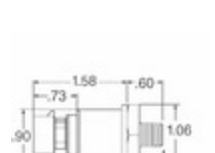
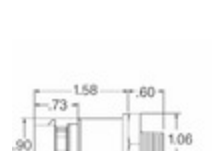
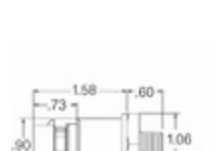
 <p>MLH250BSG13C Manufacturers: Honeywell Sensing and Productivity Solutions Description: SENSOR SEALED GAUGE 0-250 BAR In stock: 6158 pcs</p> <p>RFQ</p>	 <p>MLH250BSL14A Manufacturers: Honeywell Sensing and Productivity Solutions Description: SENSOR SEALED GAUGE 0-250 BAR In stock: 869 pcs</p> <p>RFQ</p>
 <p>MLH250BSG02B Manufacturers: Honeywell Sensing and Productivity Solutions Description: MLH ALL METAL PRESS SENSE -ATF In stock: 899 pcs</p> <p>RFQ</p>	 <p>MLH250BSG17D Manufacturers: Honeywell Sensing and Productivity Solutions Description: MLH ALL METAL PRESS SENSE -ATF In stock: 921 pcs</p> <p>RFQ</p>
 <p>MLH250BSH14A Manufacturers: Honeywell Sensing and Productivity Solutions Description: SENSOR SEALED GAUGE 0-250 BAR In stock: 1208 pcs</p> <p>RFQ</p>	 <p>MLH250BSG13D Manufacturers: Honeywell Sensing and Productivity Solutions Description: SENSOR SEALED GAUGE 0-250 BAR In stock: 6294 pcs</p> <p>RFQ</p>
 <p>MLH250BSD14E Manufacturers: Honeywell Sensing and Productivity Solutions Description: SENSOR SEALED GAUGE 0-250 BAR In stock: 923 pcs</p> <p>RFQ</p>	 <p>MLH250BSL01A Manufacturers: Honeywell Sensing and Productivity Solutions Description: MLH ALL METAL PRESS SENSE -ATF In stock: 3588 pcs</p> <p>RFQ</p>
 <p>MLH250BSG13B Manufacturers: Honeywell Sensing and Productivity Solutions Description: MLH ALL METAL PRESS SENSE -ATF In stock: 6512 pcs</p> <p>RFQ</p>	 <p>MLH250BSD17D Manufacturers: Honeywell Sensing and Productivity Solutions Description: MLH ALL METAL PRESS SENSE -ATF In stock: 5741 pcs</p> <p>RFQ</p>
 <p>MLH250BSL01B Manufacturers: Honeywell Sensing and Productivity Solutions Description: MLH ALL METAL PRESS SENSE -ATF In stock: 921 pcs</p> <p>RFQ</p>	 <p>MLH250BSG15C Manufacturers: Honeywell Sensing and Productivity Solutions Description: MLH ALL METAL PRESS SENSE -ATF In stock: 945 pcs</p> <p>RFQ</p>